

## ISOLATED DC/DC CONVERTERS

36 Vdc - 75 Vdc Input, 12 Vdc/6.5 A Output



Nov. 15, 2010

*Bel Power, Inc., a subsidiary of Bel Fuse, Inc.*

**0REB-80T12x RoHS Compliant PRELIMINARY Rev.B**

### Features

- Isolated
- High Efficiency
- Fixed Frequency (400 KHz)
- High Power Density
- Low Cost
- Class 1, Category 2, Isolated DC/DC Converter (refer to IPC-9592)
- UL60950-1 Recognized (UL/cUL) (Pending)
- Remote On/Off Logic (Optional)
- Input Under Voltage Protection
- Output Over Voltage Protection
- OCP/SCP
- Over Temperature Protection

### Applications

- Networking
- Computers and peripherals
- Telecommunications

### Description

The 0REB-80T12x is an isolated dc/dc converter that operates from a nominal 48 Vdc source. This converter provides up to 80 W of output power. Features include remote on/off, short circuit protection, over current protection, over-temperature protection, output over-voltage protection, input under-voltage protection. These converters are provided in an industry standard eighth brick package.

### Part Selection

Output Voltage	Input Voltage	Max. Output Current	Max. Output Power	Typical Efficiency	Model Number Active Low	Model Number Active High
12 Vdc	36 Vdc - 75 Vdc	6.5 A	80 W	93%	0REB-80T12L	0REB-80T120

**Notes:** Add "G" suffix at the end of the model number to indicate Tray Packaging.

### Part Number Explanation

0 R EB - 80 T 12 x  
1 2 3 4 5 6 7

- 1---Through hole mount
- 2---RoHS 6, change "R" to "7" means RoHS 5
- 3---Series name
- 4---Series code
- 5---Input range (36-75V)
- 6---Output voltage (12V)
- 7---Enable, "0" means active high, and "L" means active low

# ISOLATED DC/DC CONVERTERS

36 Vdc - 75 Vdc Input, 12 Vdc/6.5 A Output



Nov. 15, 2010

Bel Power, Inc., a subsidiary of Bel Fuse, Inc.

## Absolute Maximum Ratings

Parameter	Min	Typ	Max	Unit	Notes
Continuous non-operating Input Voltage	-0.3	-	75	V	
Input Transient Voltage	-	-	100	V	100mS maximum
Remote On/Off	-0.3	-	18	V	
I/O isolation voltage	1500	-	-	V	
Ambient Temperature	-40	-	85	°C	
Storage Temperature	-55	-	125	°C	

**Note:** Ratings used beyond the maximum ratings may cause a reliability degradation of the converter or may permanently damage the device.

## Input Specifications

Parameter	Min	Typ	Max	Unit	Notes
Operating Input Voltage	36	48	75	V	
Input Current (full load)	-	-	2.4	A	
Input Current (no load)	-	50	100	mA	
Remote Off Input Current	-	10	15	mA	
Input Reflected Ripple Current (rms)	-	2	4	mA	With simulated source impedance of 10uH, 5Hz to 20MHz. Use a 100uF/100V electrolytic capacitor with ESR=1 ohm max, at 200KHz@25°C.
Input Reflected Ripple Current (pk-pk)	-	10	20	mA	
I <sup>2</sup> t Inrush Current Transient	-	-	1	A <sup>2</sup> s	
Turn-on Voltage Threshold	33	34	35	V	
Turn-off Voltage Threshold	30	31	33	V	

**CAUTION: This converter is not internally fused. An input line fuse must be used in application.**

Recommend a fast-acting fuse with maximum rating of 3A on system board. Refer to the fuse manufacture's datasheet for further information.

**Notes:** 1. This converter has internal C-L-C (0.47uF-2.2uH-3.2uF) filter.

2. All specifications are typical at 25 °C unless otherwise stated.

## Output Specifications

Parameter	Min	Typ	Max	Unit	Notes
Output Voltage Set Point	11.76	12	12.24	V	Vin=48V, Io=50% load
Load Regulation	-	0.1	0.2	% Vo,set	Vin=48V, Io=0~100% load
Line Regulation	-	0.1	0.2	% Vo,set	Vin=36~75V, Io=100% load
Regulation Over Temperature (-40deg.C-85deg.C)	-	-	0.02	% Vo,set/C	
Ripple and Noise (pk-pk)	-	30	50	mV	Vin=48V, Io=100%load at 25°C ambient, 0-20MHz BW, with a 1µF ceramic capacitor, 10uF Tantalum cap and a 220uF electrolytic cap at output.
Ripple and Noise (rms)	-	5	10	mV	
Ripple and Noise (pk-pk) under worst case	-	-	60	mV	over all operating input voltage, load and ambient temperature condition

# ISOLATED DC/DC CONVERTERS

36 Vdc - 75 Vdc Input, 12 Vdc/6.5 A Output



Nov. 15, 2010

Bel Power, Inc., a subsidiary of Bel Fuse, Inc.

## Output Specifications (continued)

Parameter	Min	Typ	Max	Unit	Notes		
Output Current Range	0	-	6.5	A			
Output DC Current Limit	7	7.8	8.8	A			
Short Circuit Surge Transient	-	-	0.05	A <sup>2</sup> s			
Rise time	-	-	15	mS			
Turn on Time	-	25	30	mS	Enable form Vin		
	-	25	30	mS	Enable form ON/OFF		
Overshoot at Turn on	-	0	3	%			
Output Capacitance	220	-	5000	uF			
<b>Transient Response</b>							
$\Delta V$ 50%~75% of Max Load	Overshoot	Vo= 12 V	-	200	250	mV	di/dt=0.1A/us, Vin=48Vdc, Ta=25°C, with a 1μF ceramic capacitor, 10uF Tantalum cap and a 220uF electrolytic cap at output.
	Settling Time		-	350	450	uS	
$\Delta V$ 75%~50% of Max Load	Overshoot		-	200	250	mV	
	Settling Time		-	350	450	uS	

**Note:** All specifications are typical at nominal input, full load at 25°C unless otherwise stated.

## General Specifications

Parameter	Min	Typ	Max	Unit	Notes
Efficiency	90	93	-	%	Vin=48V, full load
Switching Frequency	-	400	-	kHz	
Output Voltage Trim Range	80	-	110	%	
Over Temperature Protection	-	110	120	°C	
Over Voltage Protection(Static)	13.8	-	15	V	This voltage is achieved by trimming up output slowly.
Over Voltage Protection (Dynamic)	-	-	18	V	The transient over voltage is achieved by connecting the Trim pin to Vout+ pin through a 100K resistor.
Weight	-	18	-	g	
FIT	TBD			-	Calculated Per Bell Core SR-332 (Vin=48V, Vo=12V, Io=5A, Ta = 25 °C, FIT=10 <sup>9</sup> /MTBF)
Dimensions	Inches (L x W x H) Millimeters (L x W x H)			-	2.30 x 0.90 x 0.40 58.42 x 22.86 x 10.20
<b>Isolation characteristics</b>					
Input to Output	1500	-	-	V	
Isolation Resistance	10M	-	-	Ohm	
Isolation Capacitance	-	3900	-	pF	

**Note:** All specifications are typical at 25 °C unless otherwise stated.

# ISOLATED DC/DC CONVERTERS

36 Vdc - 75 Vdc Input, 12 Vdc/6.5 A Output



Nov. 15, 2010

*Bel Power, Inc. , a subsidiary of Bel Fuse, Inc.*

## Efficiency Data

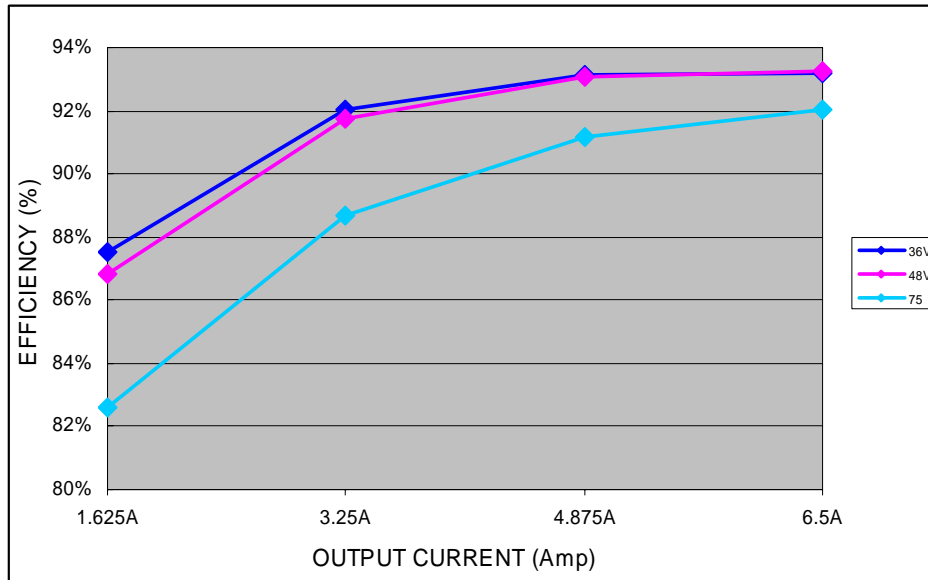

# ISOLATED DC/DC CONVERTERS

36 Vdc - 75 Vdc Input, 12 Vdc/6.5 A Output



Nov. 15, 2010

Bel Power, Inc., a subsidiary of Bel Fuse, Inc.

## Remote On/Off

Parameter		Min	Typ	Max	Unit	Notes
Signal Low (Unit On)	Active Low	-0.3	-	0.8	V	The remote on/off pin open, Unit off.
Signal High (Unit Off)		1.8	-	18	V	
Signal Low (Unit Off)	Active High	-0.3	-	0.8	V	The remote on/off pin open, Unit on.
Signal High (Unit On)		1.8	-	18	V	
Current Sink		0	-	1	mA	

### Recommended remote on/off circuit for active low

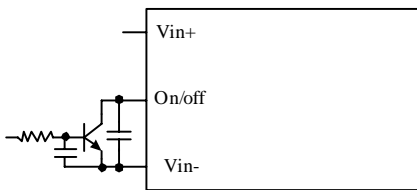

Control with open collector/drain circuit

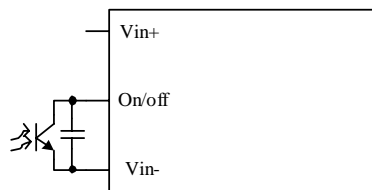

Control with photocoupler circuit

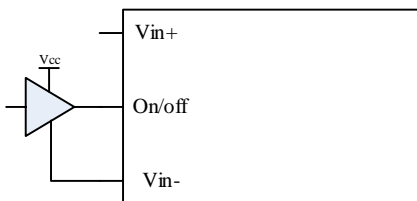

Control with logic circuit

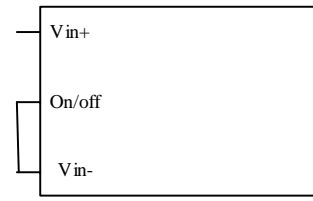

Permanently on

### Recommended remote on/off circuit for active high

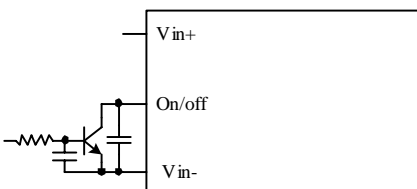

Control with open collector/drain circuit

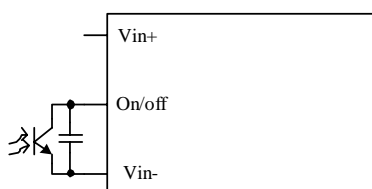

Control with photocoupler circuit

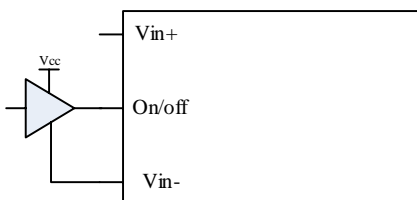

Control with logic circuit

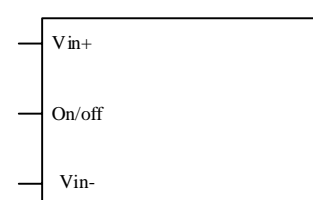

Permanently on

### Output Trim Equations

Equations for calculating the trim resistor are shown below. The Trim Down resistor should be connected between the Trim pin and Sense (-) pin. The Trim Up resistor should be connected between the Trim pin and the Sense (+). Only one of the resistors should be used for any given application.

Minimum trim down voltage is 9.6V  
Maximum trim up voltage is 13.2V.

The total voltage increased by trim and remote sense should not exceed 10% of the nominal output voltage.

$$R_{trimdown} = \frac{511}{|\delta|} - 10.22 [k\Omega]$$

$$R_{trimup} = \frac{(100 + \delta) \cdot V_o \cdot 5.11 - 626}{1.225 \cdot \delta} - 10.22 [k\Omega]$$

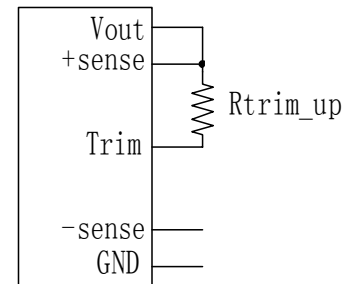
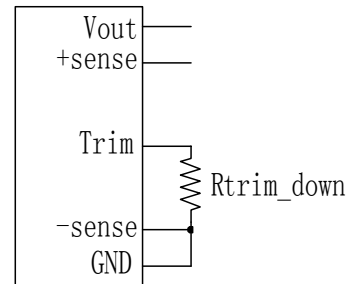

**Note:**

$$\delta = \frac{(V_o_{req} - V_o)}{V_o} \times 100 [\%]$$

$V_o_{req}$  = Desired (trimmed) output voltage [V]  
Output voltage  $V_o$  = 12.000 V

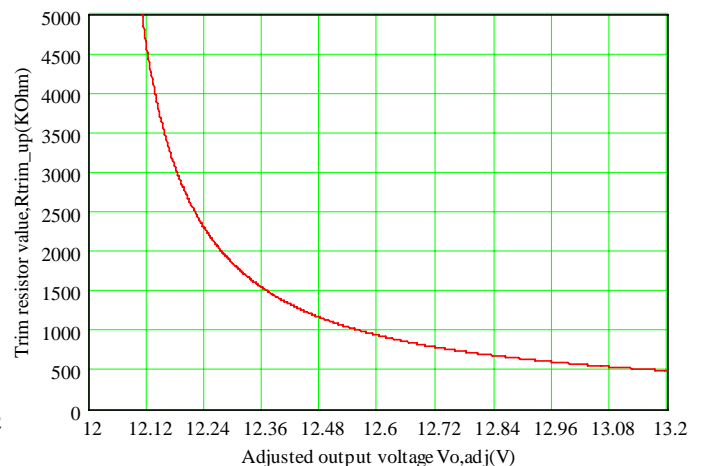
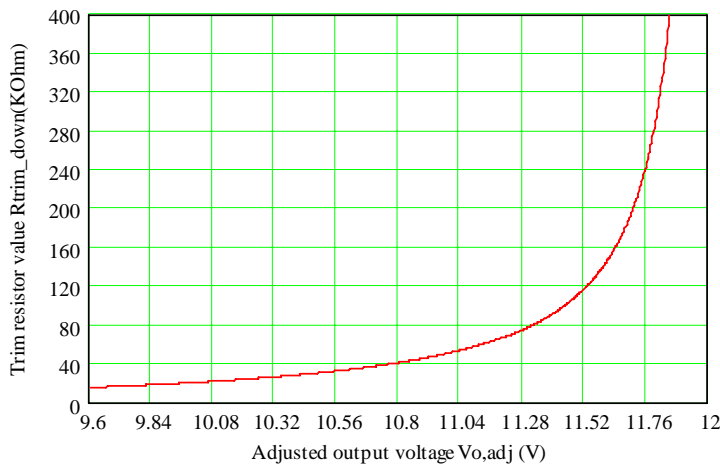

## ISOLATED DC/DC CONVERTERS

36 Vdc - 75 Vdc Input, 12 Vdc/6.5 A Output

**bel**

Nov. 15, 2010

*Bel Power, Inc. , a subsidiary of Bel Fuse, Inc.*

### Remote Sense

This module has remote sense compensation feature. It can minimize the effects of resistance between module's output and load in system layout and facilitates accurate voltage regulation at load terminals or other selected point.

1. The remote sense lines carries very little current and hence do not require a large cross-sectional area.
2. This module compensates for a maximum drop of 10% of the nominal output voltage.
3. If the unit is already trimmed up, the available remote sense compensation range should be correspondingly reduced. The total voltage increased by trim and remote sense should not exceed 10% of the nominal output voltage.
4. When using remote sense compensation, all the resistance, parasitic inductance and capacitance of the system are incorporated within the feedback loop of this module. It can make an effect on the module's compensation, affecting the stability and dynamic response. A 0.1uF ceramic capacitor can be connected at the point of load to de-couple noise on the sense wires.
5. Recommend the connection of remote sense compensation as below figure. There are a resistor RS+ (40.2 ohm) from Vo+ to Sense+ and a resistor RS- (40.2 ohm) from Vo- to Sense- inside of this module.

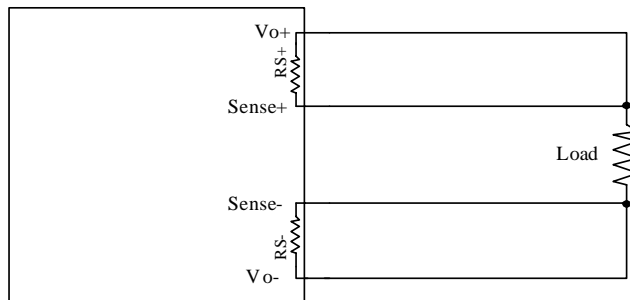

6. If not using remote sense compensation, please connect sense directly to output at module's pin, that is, connect sense+ to Vo+ and sense- to Vo- at module's pin, the shorter the better. See below figure.

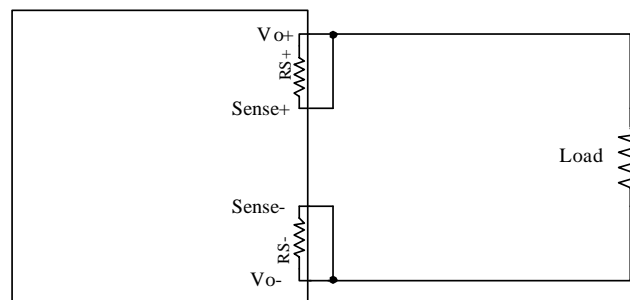

# ISOLATED DC/DC CONVERTERS

36 Vdc - 75 Vdc Input, 12 Vdc/6.5 A Output



Nov. 15, 2010

Bel Power, Inc., a subsidiary of Bel Fuse, Inc.

## Over Current Protection

To provide protection in a fault output overload condition, the module is equipped with internal current-limiting circuitry and can endure current limiting for a few milli-seconds. If the over current condition persists beyond a few milliseconds, the module will shut down into hiccup mode and restart once every 300mS. The module operates normally when the output current goes into specified range. The typical average output current is 1.75A during hiccup.

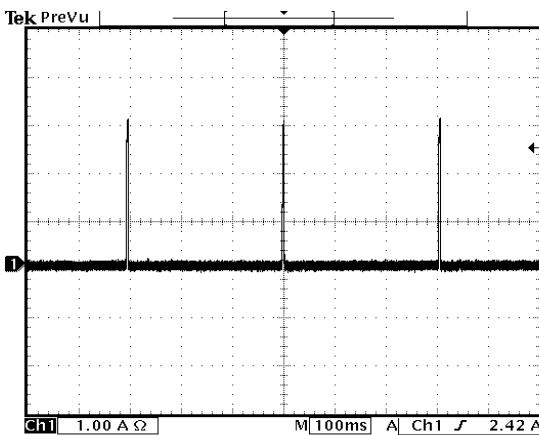

Vin=48V

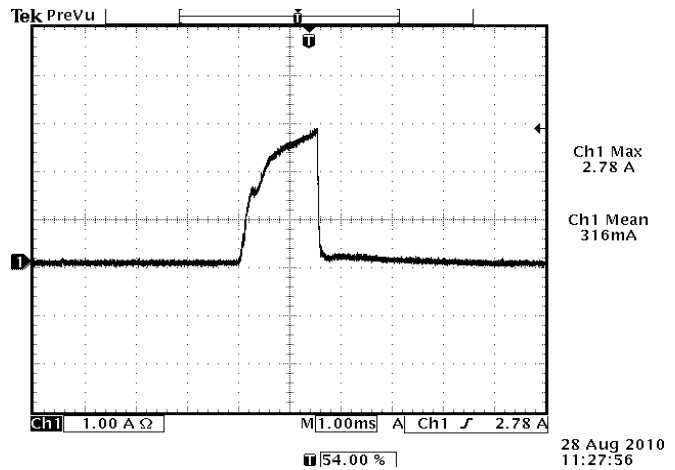

Expansion of on time portion

## Over Voltage Protection

The output over voltage protection consists of circuitry that monitors the voltage on the output terminals. If the voltage on the output terminals exceeds the over voltage protection threshold, the module will shutdown into hiccup mode and restart once every 300mS. The module operates normally when the fault is cleared.

Test setup:

Waveform: CH1: Output voltage waveform

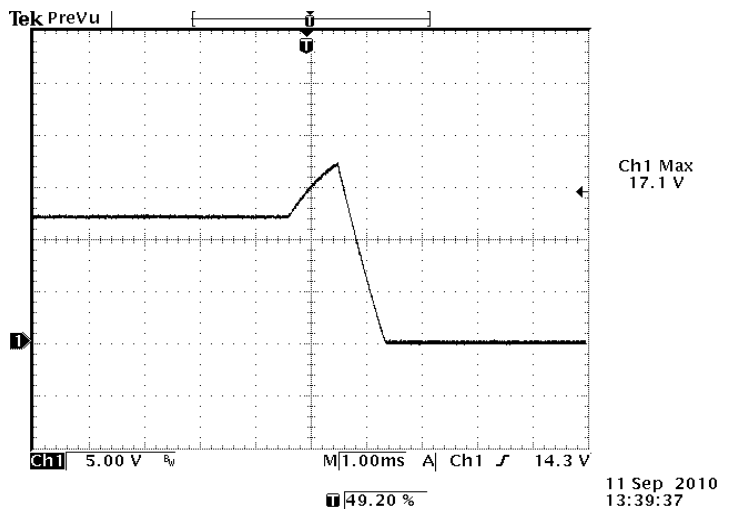
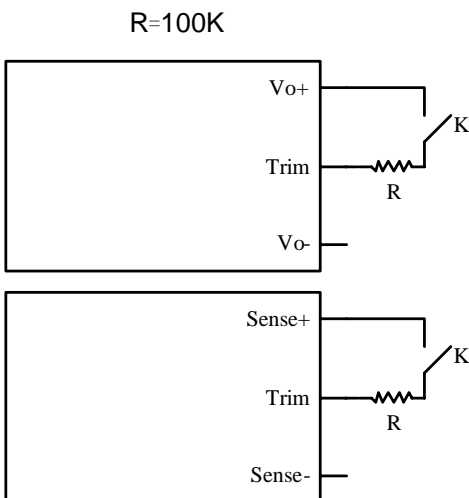



# ISOLATED DC/DC CONVERTERS

36 Vdc - 75 Vdc Input, 12 Vdc/6.5 A Output



Nov. 15, 2010

Bel Power, Inc., a subsidiary of Bel Fuse, Inc.

## Over Temperature Protection

The OTP is achieved by thermistor R67 and the threshold is set at 110C in non-latch mode; the hottest component Q3 reaches 112C with 100LFM air flow correspondingly. It will restart automatically when the temperature falls down to 105C. The protecting point will be varied a little under different conditions (air flow, ambient temperature, input voltage, load...).

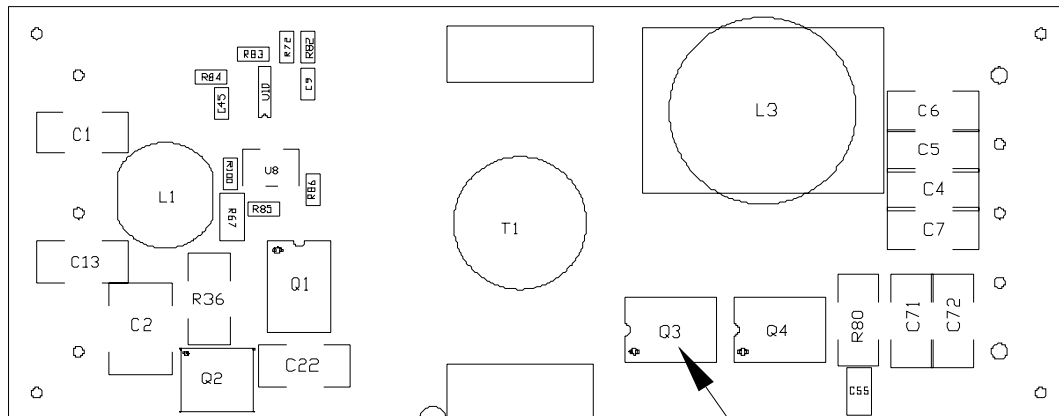

TOP VIEW

Tref

## Input Under-voltage Lockout

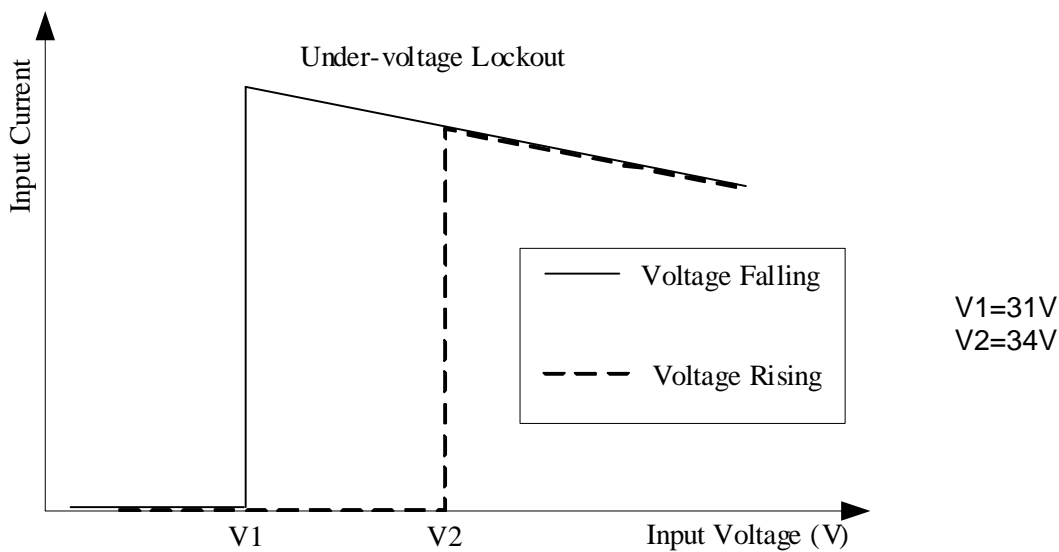

# ISOLATED DC/DC CONVERTERS

36 Vdc - 75 Vdc Input, 12 Vdc/6.5 A Output



Nov. 15, 2010

Bel Power, Inc., a subsidiary of Bel Fuse, Inc.

## Ripple and Noise Waveform

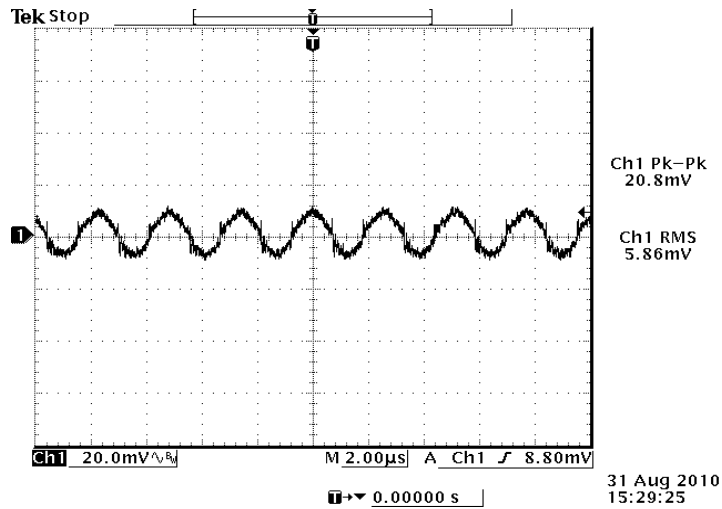

48Vdc input, 12Vdc/6.5A output

**Note:** Ripple and noise at full load, with a 1µF ceramic cap and a 10 µF Tantalum cap and a 220µF electrolytic cap at output,  $T_a=25$  deg C.

## Transient Response Waveforms

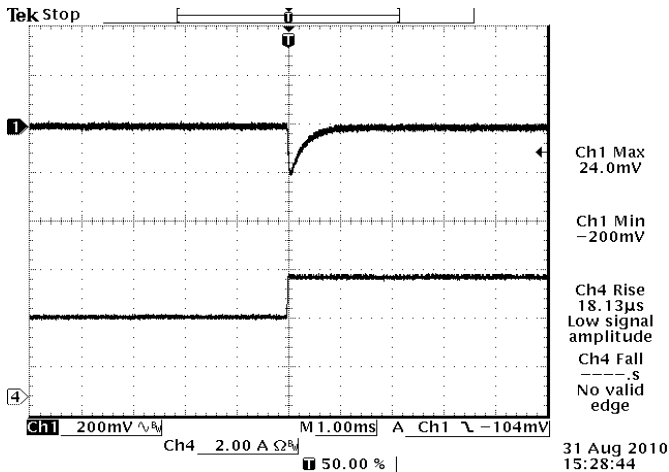

Vout= 12V 50%-75% Load Transients

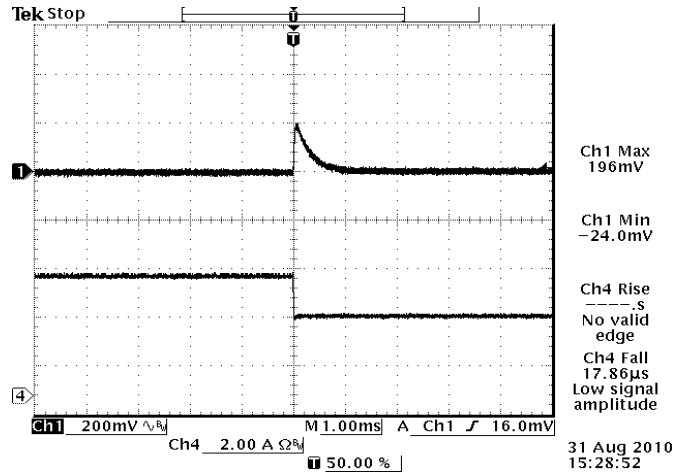

Vout= 12V 75%-50% Load Transients

**Note:** Transient Response at  $V_{in}=48V$ ,  $di/dt=0.1A/\mu s$ , with a 1µF ceramic cap and a 10µF aluminum cap and a 220µF electrolytic cap at the output.

# ISOLATED DC/DC CONVERTERS

36 Vdc - 75 Vdc Input, 12 Vdc/6.5 A Output



Nov. 15, 2010

Bel Power, Inc., a subsidiary of Bel Fuse, Inc.

## Startup & Shutdown

### Rise Time

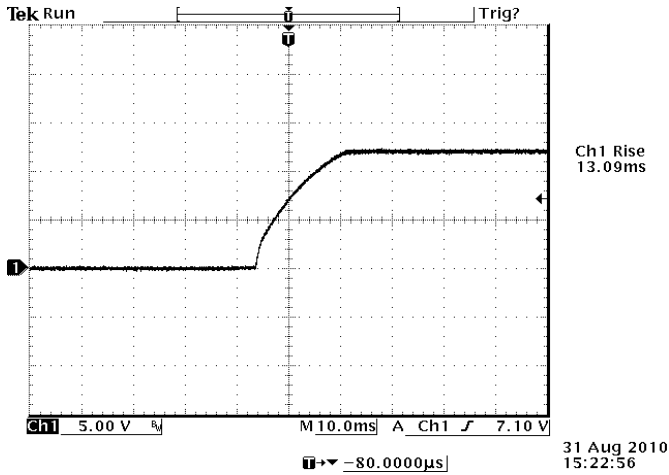

Vin=48V, Vo=12V, Io=6.5A

### Startup time

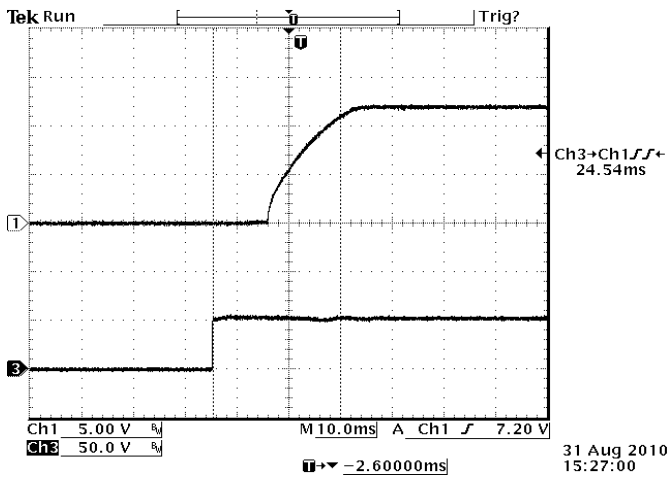

Startup from Vin  
Ch1: Vo  
Ch3: Vin  
Vin=48V, Vo=12V, Io=6.5A

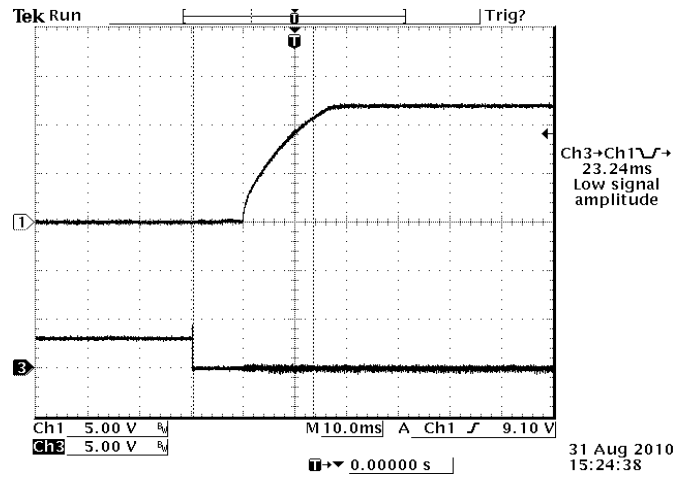

Startup from on/off  
Ch1: Vo  
Ch3: on/off  
Vin=48V, Vo=12V, Io=6.5A

# ISOLATED DC/DC CONVERTERS

36 Vdc - 75 Vdc Input, 12 Vdc/6.5 A Output



Nov. 15, 2010

Bel Power, Inc., a subsidiary of Bel Fuse, Inc.

## Startup & Shutdown (continued)

### Shutdown

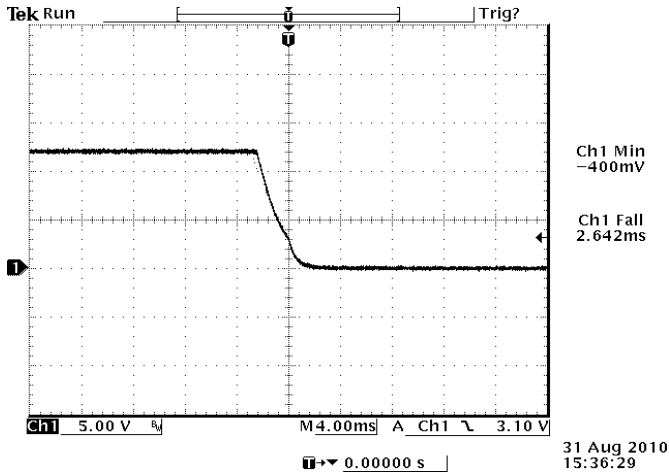

Vin=48V, Vo=12V, Io=6.5A

## Thermal Derating Curve

Maximum junction temperature of semiconductors derated to 120 degree C.

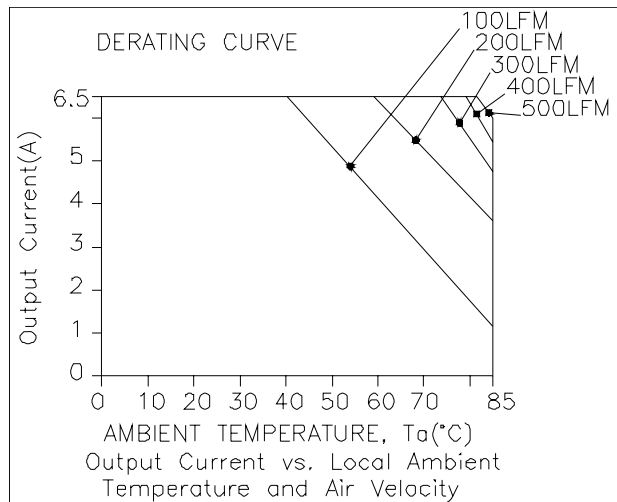
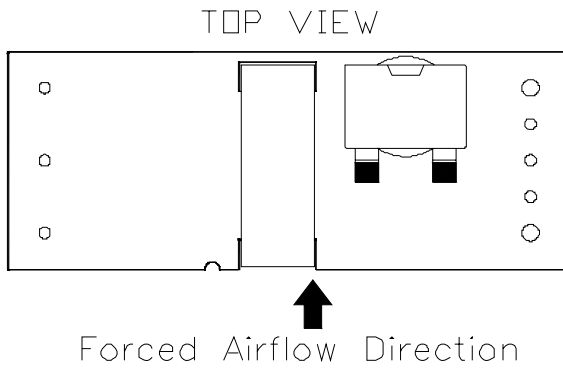

Derating curve under normal input



## ISOLATED DC/DC CONVERTERS

36 Vdc - 75 Vdc Input, 12 Vdc/6.5 A Output



Nov. 15, 2010

Bel Power, Inc., a subsidiary of Bel Fuse, Inc.

### Safety & EMC

#### Safety

1. Material flammability UL94V-0
2. TUV Certification EN60950-1
3. UL Certification UL60950-1

#### EMC

1. Surge IEC61000-4-5
2. DC-DIP IEC61000-4-29
3. Conductive EMI EN55022 class A

Compliance to EN55022 class A (both q.peak and average) with the following inductive and capacitive filter

Setup:

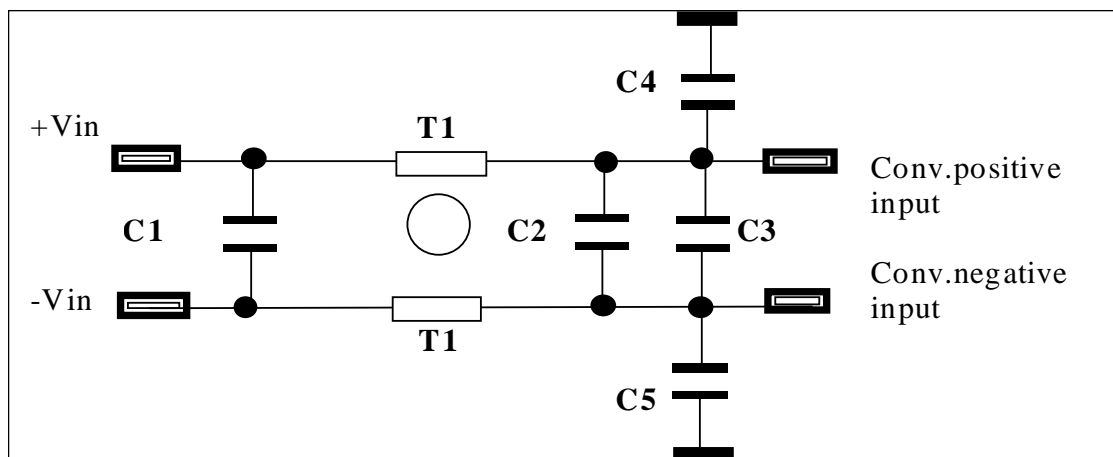

Item	Designator	Parameter	Vendor	Vendor P/N
1	C1	1uF/100V,ceramic	Murata	GRM32ER72A105KA01L
2	C2	0.1uF/100V, ceramic	TDK	C3216X7R2A104K
3	C3	100uF/100V, AL cap	Nichicon	UVZ2A101MPD
4	C4	22nF/1000V,ceramic	Johanson	631S41W223KV4E
5	C5	22nF/1000V,ceramic	Johanson	631S41W223KV4E
6	T1	1.3mH, common mode	Pulse	P0402NL

# ISOLATED DC/DC CONVERTERS

36 Vdc - 75 Vdc Input, 12 Vdc/6.5 A Output



Nov. 15, 2010

Bel Power, Inc., a subsidiary of Bel Fuse, Inc.

## Layout

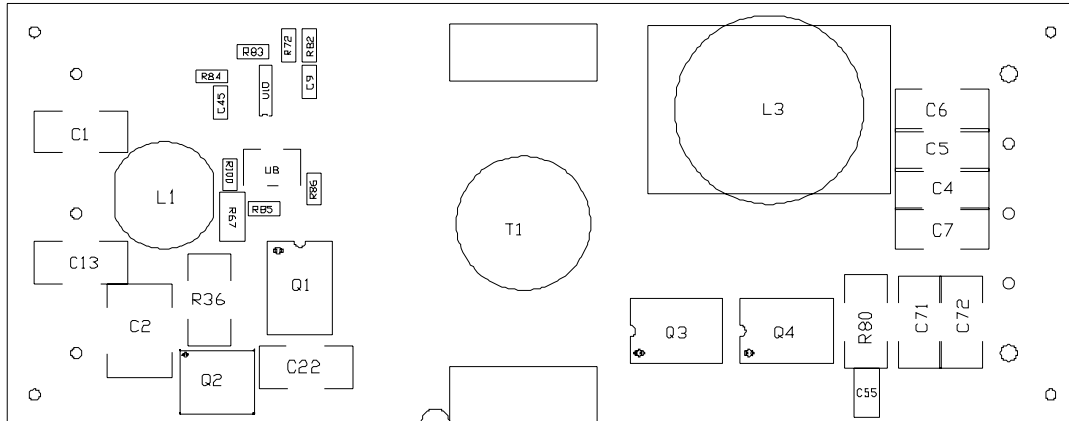

Layout of components on top side

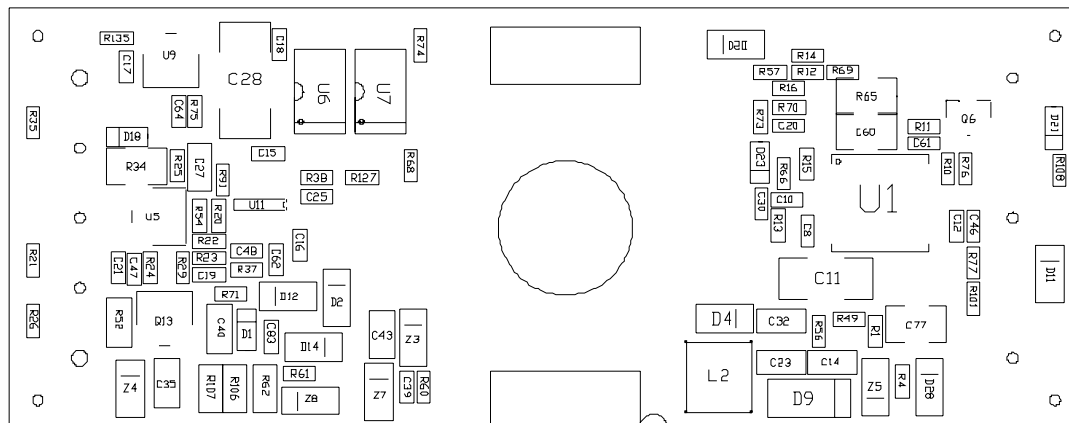

Layout of components on bottom side

# ISOLATED DC/DC CONVERTERS

36 Vdc - 75 Vdc Input, 12 Vdc/6.5 A Output



Nov. 15, 2010

Bel Power, Inc., a subsidiary of Bel Fuse, Inc.

## Mechanical Outline

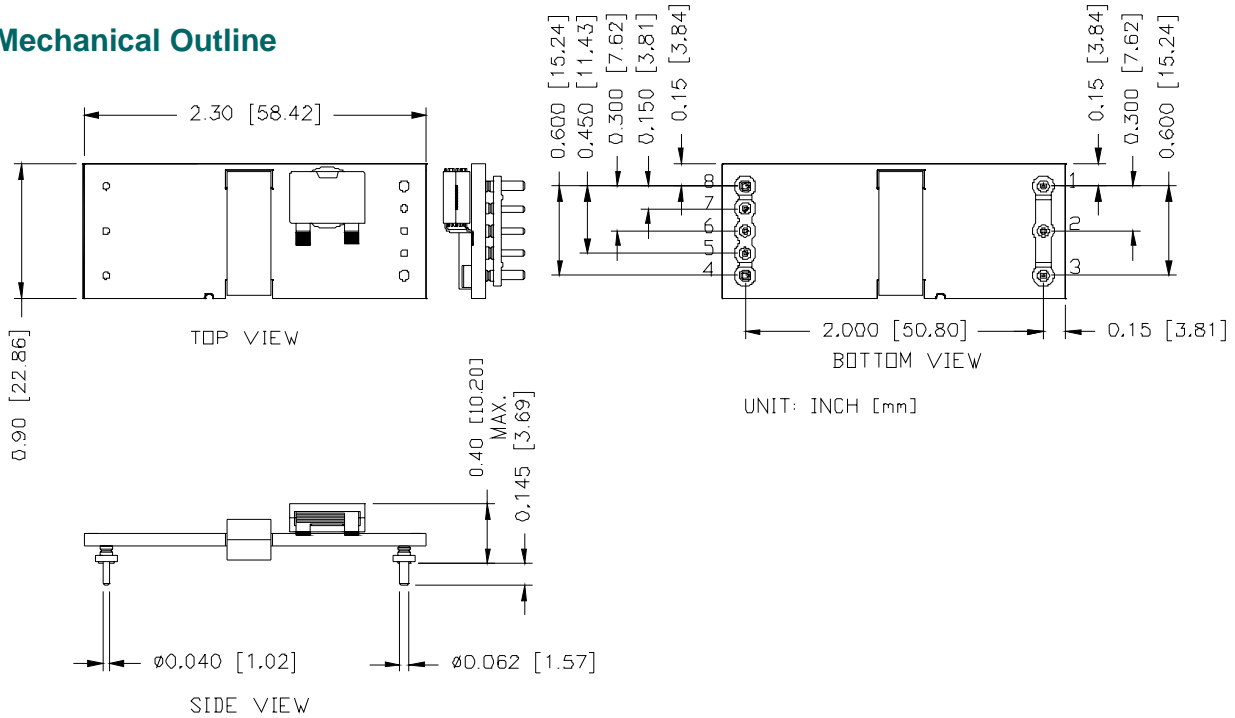

### RECOMMENDED PAD LAYOUT

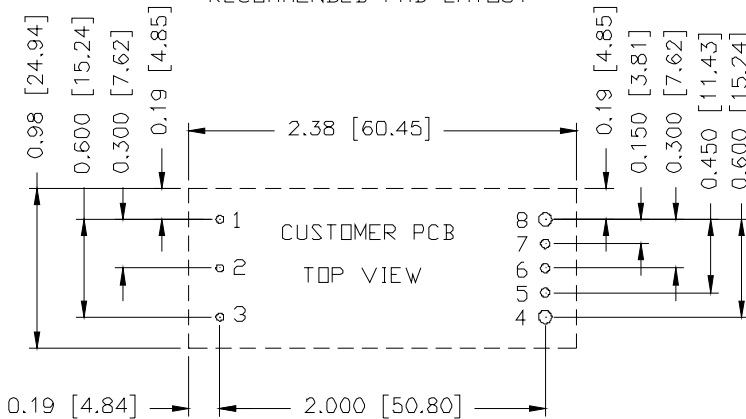

Pin	Function	Dia.
1	Vin(+)	0.04"
2	RC	0.04"
3	Vin(-)	0.04"
4	Vout(-)	0.062"
5	RS-	0.04"
6	TRIM	0.04"
7	RS+	0.04"
8	Vout(+)	0.062"

**Note:** 1. Pin 5 must be connected to Vout(-)  
2. Pin 7 must be connected to Vout(+)

1,2,3,5,6,7  $\varnothing 0.047$  HOLE SIZE,  $\varnothing 0.08$  min PAD SIZE  
4,8  $\varnothing 0.07$  HOLE SIZE,  $\varnothing 0.10$  min PAD SIZE

**Note:** This module is recommended and compatible with Pb-Free Wave Soldering and must be soldered using a peak solder temperature of no more than 260 °C for less than 5 seconds.

### Note:

- 1) All Pins: Material - Copper Alloy;  
Finish – 3 micro inches minimum Gold over 50 micro inches minimum Nickel plate.
- 2) Undimensioned components are shown for visual reference only.
- 3) All dimensions in inches (mm); Tolerances: x.xx +/-0.02 in. (x.x +/-0.5mm) x.xxx +/-0.010 in. (x.xx +/-0.25mm).



# ISOLATED DC/DC CONVERTERS

36 Vdc - 75 Vdc Input, 12 Vdc/6.5 A Output



Nov. 15, 2010

*Bel Power, Inc. , a subsidiary of Bel Fuse, Inc.*

## Revision History

Date	Revision	Changes Detail	Approval
2010-09-11	PA	First release	XF Jiang
2010-11-15	PB	1. Updated Turn-on/off voltage threshold in Input specifications. 2. Updated Load regulation, Line regulation, Output ripple and noise, Output DC current limit, Turn on time, Output capacitance, Transient response in Output specifications 3. Updated Remote on/off.	XF Jiang

### RoHS Compliance

Complies with the European Directive 2002/95/EC, calling for the elimination of lead and other hazardous substances from electronic products.



©2010 Bel Fuse Inc. Specifications subject to change without notice. 111510

17

#### CORPORATE

**Bel Fuse Inc.**  
206 Van Vorst Street  
Jersey City, NJ 07302  
Tel 201-432-0463  
Fax 201-432-9542  
[www.belfuse.com](http://www.belfuse.com)

#### FAR EAST

**Bel Fuse Ltd.**  
8F/ 8 Luk Hop Street  
San Po Kong  
Kowloon, Hong Kong  
Tel 852-2328-5515  
Fax 852-2352-3706  
[www.belfuse.com](http://www.belfuse.com)

#### EUROPE

**Bel Fuse Europe Ltd.**  
Preston Technology Management Centre  
Marsh Lane, Suite G7, Preston  
Lancashire, PR1 8UD, U.K.  
Tel 44-1772-556601  
Fax 44-1772-888366  
[www.belfuse.com](http://www.belfuse.com)